

ZW-7 series

HITACHI

Reliable solutions

**ZW220**



## WHEEL LOADER

Model code : ZW220-7

Engine maximum power : 157kW/210hp (ISO14396)

Operating weight : 18 190 – 18 610 kg

Bucket ISO heaped : 2.8 – 10.0 m<sup>3</sup>



# YOU'RE IN CONTROL

You're at the heart of Hitachi's design for its latest range of wheel loaders. To continuously improve on previous generation machines, we've focused on enhancing your experience in the cab as an operator.

We've considered the challenges you face as the owner of a successful business. And we've zoomed in on the ways in which we can support you over the life cycle of your machine.

By putting you at the heart of the ZW-7 range, we invite you to take control – over your workspace and your fleet. And by working in partnership, we will help you to create your vision.



# INSIDE



**4. Complete Control**  
In control of your assets



**6. Increase your safety**  
Be in control of your environment



**8. Boost your uptime**  
Improve your profit

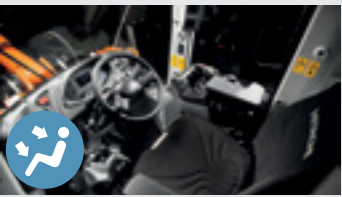

**13. Control Zone**  
Feel the difference



**16. Manage your machine**  
In control of your performance



**22. Specifications**  
Know your machine

# COMPLETE CONTROL

The new ZW-7 range of wheel loaders puts you firmly in control, so you can feel assured of your machine's performance, and supported by the technological expertise and services that Hitachi provides.

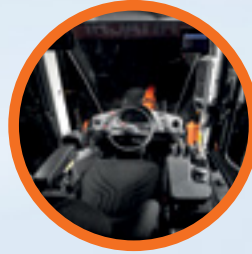

The cab interior provides a comfortable working environment.



Approach speed control maximises fuel efficiency on loading operations.



The payload checker helps you work more productively and accurately when loading trucks.



ConSite Pocket app allows you to manage and monitor your fleet remotely.



Options such as Hitachi ground engaging tools enable you to enhance the performance of your wheel loader.

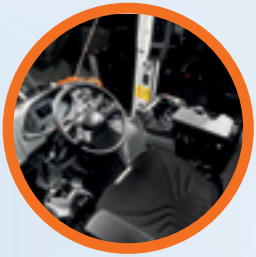

Integrated console and seat suspension gives a greater sense of control and seat-mounted electric control levers reduce fatigue.

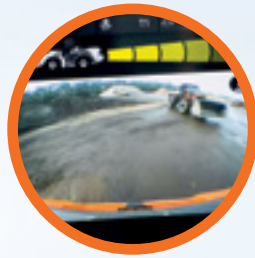

Visibility of the job site is excellent thanks to the Aerial Angle® camera system (optional) and new LCD monitor.



Safety is enhanced by the rear obstacle detection and warning system (optional).



The ECO gauge on the monitor indicates how to lower fuel consumption and reduce costs.



Maintenance is quick and easy due to improved access to components and anti-clogging radiators.



Higher engine output at lower engine RPM increases performance.



# INCREASE YOUR SAFETY

Your ability to work safely is vital, not only for your own wellbeing, but also for the successful completion of any project. To protect yourself and your machine from potential hazards, the new Hitachi ZW-7 wheel loaders give you a superior view of your surroundings, so you can see the job site from all angles.

The visibility you enjoy from the cab includes an exceptional 270-degree bird's-eye view with the Aerial Angle® camera system. You can choose from two image options to view the machine's immediate environment, which enables you to control your own safety – as well as that of those around you.

The rear obstacle detection system also enhances safety on the job site, with real-time speed, machine position status and large detection zone.

To help you to work more confidently and efficiently, even in the most challenging of conditions, ZW-7 wheel loaders are fitted with some impressive new features. From the LED work lights (in two variants: standard 1200lm and high brightness 4200lm) and roller sunshade, you'll have the visibility you need when it matters most.



Electrically adjusted mirrors provide a clear rear view.



Rear obstacle detection system enhances safety on the job site.



Choose between different image layouts to suit your working environment.



LED work lights improve visibility in challenging conditions.

# BOOST YOUR UPTIME

Completing a project on time and on budget depends on the ability of your construction equipment to perform all day, every day. That's why Hitachi owners have profited from generations of ultra-reliable and durable machinery – and the ZW-7 range is no exception.

The latest Hitachi wheel loaders have been built to last, so that you can remain in complete control of your assets. They have been tested rigorously and continuously at dedicated facilities in Japan with the goal of significantly boosting your uptime.

As a result, several unique durability-enhancing components have been fitted to the latest Stage-V compliant machines. The axle overheat prevention system on the monitor warns your operator of high brake loads. And the intelligent fan operation system prevents radiators from clogging by adjusting the periodic intervals of the automatic reversible fan electronically.

Downtime is minimised by the priority given to easy maintenance features, such as anti-clogging radiators, which save you time and money.



Daily inspection reminders make life easier for operators.



Easy maintenance features minimise downtime.



Intelligent fan operation system prevents radiators clogging.



Engine cover enables convenient access for daily inspections.



Hitachi wheel loaders are tested rigorously to ensure high levels of durability.



# IMPROVE YOUR PROFIT

The success of your business depends on the reliability and efficiency of your construction machinery. With Hitachi's latest ZW-7 wheel loaders, you can count on the highest quality, the ultimate in operating comfort and reduced running costs – all of which will have a positive impact on your bottom line.

You can look forward to increasing your profits thanks to the impressive fuel economy and efficient operation of these new ZW-7 compliant machines. The new ZW220-7 delivers further reductions in fuel consumption and greater efficiency with features such as approach speed control. This allows operators to control the travelling speed on short loading operations, which results in less fuel consumption.

Another way for your operators to control fuel efficiency – and reduce costs – is by using the all-new ECO gauge. This is clearly visible on the multifunctional colour LCD 3.5" monitor.

Your operators can also work more productively and accurately thanks to the payload checker. This enables them to keep track of load weights in real time on the monitor and find out how much material is in the bucket or truck. The display shows when the bucket or truck is overloaded, so you can adjust the final load to achieve target capacity.



Work more productively and accurately using the payload checker.



The ECO gauge helps to deliver better fuel consumption.



Approach speed control maximises efficiency.



9

10

11

12

13

16

17

14

15

4

3

2

5

6

8

7

# CONTROL ZONE

Enhanced comfort and safety features are at your fingertips in the refined cab of ZW-7 wheel loaders, giving you the power to perform productively, with ease and reduced fatigue.

- 1 **Seat-mounted electric control levers** help to reduce fatigue.
- 2 **Multifunction or finger-type control lever** options to suit your preference.
- 3 **Integrated console and seat suspension** gives a greater sense of control.
- 4 **USB power supply and smartphone holder** helps you stay connected.
- 5 **Armrest-Integrated sub monitor controller** provides fast access to main functions.
- 6 **Ergonomically designed adjustable armrest** so you can work comfortably.
- 7 **User-friendly storage space** keeps your workspace tidy and clutter-free.
- 8 **Heated heavy duty seat** with horizontal suspension.
- 9 **Drinks holder** is easy to detach for cleaning.
- 10 **Joystick Steering System** (optional) provides exceptional control.
- 11 **Anti-slip steering wheel** for effortless operation.
- 12 **3.5" colour liquid crystal display** in the front dashboard is easy to view.
- 13 **Spacious cab** gives you a pleasant working environment.
- 14 **Panel switch integrated functions** are user-friendly.
- 15 **Electrically adjusted mirrors switch** is easy to use.
- 16 **High-resolution 8" monitor** is easy to use and navigate.
- 17 **Bluetooth®** for hands-free calls and DAB+ radio for music while you work. Audio is easily controlled.



Operation is easy with ergonomically designed controls and switches.



All commonly used functions can be selected at a glance using the side panel switch.



# FEEL THE DIFFERENCE

Hitachi's redesigned, state-of-the-art ZW-7 cab gives you the perfect working environment. The ultra-spacious ZW220-7 offers you an industry-leading, first-class cab with the ultimate in comfort and quality, as well as some of the lowest noise and vibration levels in the market.

Feel the difference with the synchronised motion of the seat and console, and seat-mounted electric control levers, which have been designed to ensure you feel less tired at the end of the working day.

Easy operation comes with the ergonomic design of the multifunction lever, the anti-slip steering wheel and the adjustable armrest with integrated controller. You can navigate quickly through the menu on the 8" LCD monitor with the sub monitor controller. The hi-res screen is also easier to view, and the refreshed layout offers a clear display and desirable functionality.

With more storage for your personal belongings, such as your coat, smartphone and drink, you'll feel instantly relaxed and ready for your shift. Practical functions of the joystick steering system, such as wiper and horn, will make your working day effortless and enjoyable.



You're in control with a spacious, tidy and enjoyable working environment.



The LCD monitor is easy to view with hi-res screen.



Ergonomically placed sub monitor controller provides easy access.



The cab has ample space for your belongings.

# MANAGE YOUR MACHINE

Hitachi offers a wide range of after-sales services to help you feel in total control of your fleet and workload. These initiatives give you access to vital data and tools to manage your machine.

Remote monitoring systems Owner's Site and ConSite send operational data daily via GPRS or satellite from your wheel loader to [www.globaleservice.com](http://www.globaleservice.com). This includes: ratios of operating hours to enhance efficiency; fuel consumption to manage running costs; and machine location for planning purposes. ConSite summarises the information in a monthly email.

The ConSite Pocket App sends you real-time alerts for issues arising with your machine. You'll receive recommendations on what to do and step-by-step help guides. The app also enables you to see the location of your fleet.

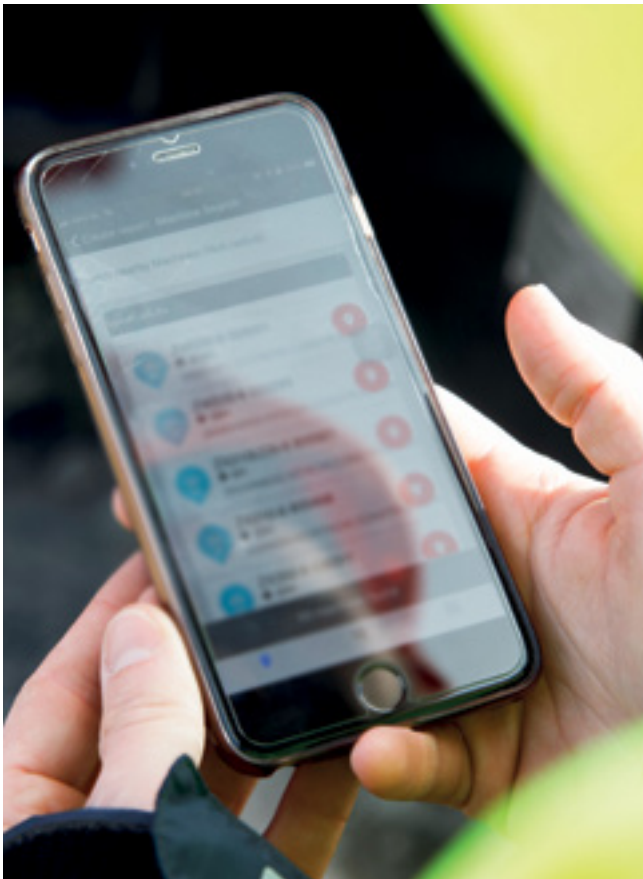

The alerts on the ConSite Pocket App provide real-time information.



A wide range of data on Global e-Service enhances efficiency.



Monitoring the performance of your wheel loader ensures exceptional reliability.



Hitachi offers a wide range of after-sales services for planning maintenance and managing running costs.



Minimise downtime with Hitachi Genuine Parts.



HELP extended warranties and service contracts provide optimal performance.



Hitachi Premium Rental enables you to pay as you earn.



# PROTECT YOUR INVESTMENT

If your machine will be working in severe conditions, or you want to minimise repair costs, you can take advantage of a unique extended warranty programme called HELP (Hitachi Extended Life Program) and comprehensive service contracts. These can help to optimise performance, reduce downtime and ensure a higher resale value.

We apply the same technological expertise to our wide range of high-quality parts as we do our machines. As a result, you can minimise unscheduled downtime and ensure maximum availability.

The parts range includes Hitachi Genuine Parts, Performance Parts, filters, undercarriages, and remanufactured components. We also offer ground engaging tools and buckets, which have been manufactured to the same exacting standards.

As your business grows, you may need to extend your fleet to meet the demands of new contracts. Why not try before you buy with the Hitachi Premium Rental programme? This gives you immediate access to ZW-7 wheel loaders for a period of one month to a year.

Along with the reliability, quality and service you would expect from the Hitachi brand, Hitachi Premium Rental offers flexible contracts and fixed costs that make it easier for you to budget.



# IN CONTROL OF YOUR WORLD



EH dump trucks and EX ultra-large excavators



EH dump trucks and EX ultra-large excavators



With extensive expertise in designing and manufacturing wheel loaders, as well as a 50-year heritage in producing hydraulic excavators and a reputation as the industry's leading mining machine manufacturer, the Hitachi network will give you access to a range of exceptional construction equipment.

Like the new ZW-7 wheel loaders, Hitachi excavators, rigid dump trucks, and special application machines incorporate advanced technology and pioneering expertise. This is inspired by parent company Hitachi Ltd, which was founded on the philosophy to make a positive contribution to society through technology.

In addition to the latest products made at state-of-the-art facilities and built to the highest quality standards, you'll have the support of our experienced engineers and dedicated dealer personnel. You'll also benefit from market-leading services and initiatives, such as Premium Used, which have been created to enhance your experience as a Hitachi customer.

Whatever vision you wish to create, Hitachi has the product, people, solutions and services you need to make it become a reality – and empower you to take control of your world.



Zaxis medium excavators



Zaxis mini excavators

# SPECIFICATIONS

## ENGINE

Model	CUMMINS B6.7
Type	4 cycle water-cooled, direct injection
Aspiration	Turbocharger and intercooled
Aftertreatment	DPF+SCR system
No. of cylinders	6
<b>Maximum power</b>	
ISO 14396	157 kW (210 hp) at 1 900 min <sup>-1</sup> (rpm)
ISO 9249 : 2007 net	152 kW (204 hp) at 1 900 min <sup>-1</sup> (rpm)
<b>Rated power</b>	
ISO 14396 : 2002 gross	149 kW (200 hp) at 2 200 min <sup>-1</sup> (rpm)
ISO 9249 : 2007 net	144 kW (193 hp) at 2 200 min <sup>-1</sup> (rpm)
<b>Maximum torque</b>	
ISO 9249 : 2007 net	990 Nm at 1 300 min <sup>-1</sup> (rpm)
Bore and stroke	107 mm X 124 mm
Piston displacement	6.69 L
Batteries	2 x 12 V
Air cleaner	Two element dry type with restriction indicator

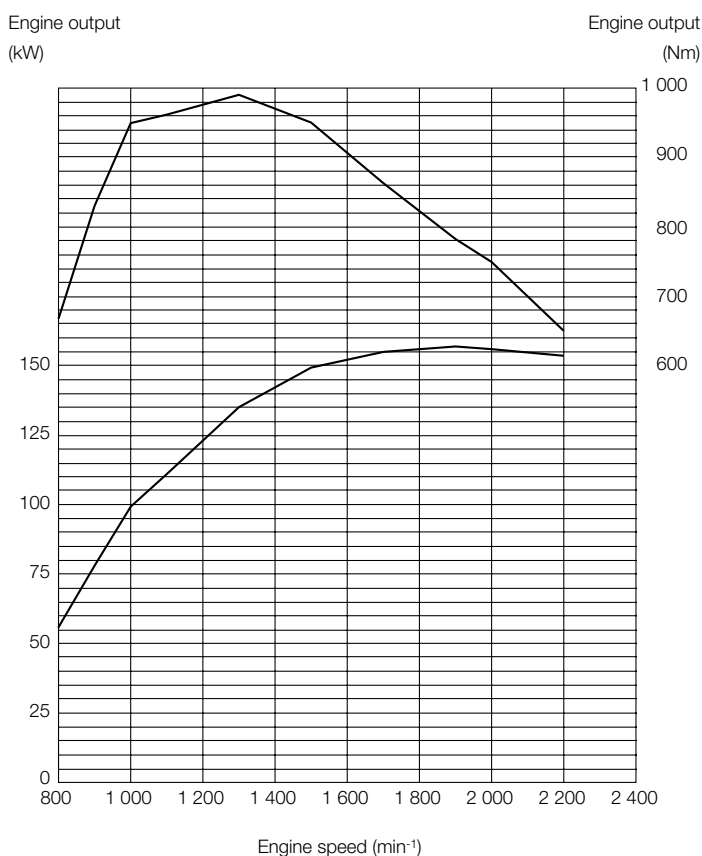

## POWER TRAIN

Transmission	Torque convertershaft type powershift with computer-controlled automatic shift and manual shift features included.
Torque converter	Three element, single stage, single phase
Main clutch	Wet hydraulic, multi-disc type
Cooling method	Forced circulation type
<b>Travel speed* Forward / Reverse</b>	
1st	6.3 / 6.6 km/h (6.3 / 6.7 km/h)
2nd	10.9 / 11.4 km/h (11.4 / 12.0 km/h)
3rd	16.0 / 24.8 km/h (17.3 / 26.9 km/h)
4th	23.7 km/h (25.7 km/h)
5th	36.3 km/h (36.3 km/h)

\*With 23.5R25 (L3) tires  
( ) : Data at Power Mode

## AXLE AND FINAL DRIVE

Drive system	Four-wheel drive system
Front and rear axle	Semi-floating
Front	Fixed to the front frame
Rear	Trunnion support
Reduction and differential gear	Two stage reduction with torque proportioning differential (std) / limited slip differential (optional)
Oscillation angle	Total 24° (+12°, -12°)
Final drives	Heavy-duty planetary, mounted inboard

## TIRES

Tire size	23.5R25 (L3)
Optional	Refer to standard & optional equipment list

## BRAKES

Service brakes	Inboard mounted fully hydraulic 4 wheel wet disc brake. Front and rear independent brake circuit
Parking brakes	Spring applied, hydraulically released, dry disc type with external output shaft

## STEERING SYSTEM

Type	Articulated frame steering
Steering angle	Each direction 37°; total 74°
Cylinders	Double-acting piston type
No. x Bore x Stroke	2 x 70 mm x 442 mm

## HYDRAULIC SYSTEM

Arm and bucket are controlled by multifunction lever

Arm controls Four position valve; Raise, hold, lower, float

Bucket controls with automatic bucket return-to-dig control

Three position valve; Roll back, hold, dump

Main pump (Serve as steering pump)

Variable Displacement Axial Plunger Pump

Maximum flow 275 L/min at 2 200 min<sup>-1</sup> (rpm)

Maximum pressure 27.4 MPa

Fan pump

Fixed Displacement Gear Pump

Maximum flow 65.8 L/min at 2 200 min<sup>-1</sup> (rpm)

Maximum pressure 19.0 MPa

Hydraulic cylinders

Type Double acting type

No. x Bore x Stroke Arm: 2 x 130 mm x 880 mm

Bucket: 1 x 165 mm x 510 mm

Filters Full-flow 9 micron return filter in reservoir

Hydraulic cycle times

Lift arm raise 5.6 s

Lift arm lower 3.3 s

Bucket dump 1.5 s

Total 10.4 s

\*Data at Power Mode

## ENVIRONMENT

### Engine Emissions

EU stage V

### Sound level

Sound level in cab according to ISO 6396 LpA 68 dB(A)

External sound level according to ISO 6395 and EU Directive 2000/14/EC LwA 105 dB(A)

### Air Conditioning System

The air conditioning system contains fluorinated greenhouse gases.

Refrigerant type: HFC-134a, GWP: 1430, Amount: 0.80±0.05 kg, CO<sub>2</sub>e: 1.14±0.07 ton.

## SERVICE REFILL CAPACITIES

Fuel tank 255 L

Engine coolant 29 L

Engine oil 25 L

Torque converter and transmission 27 L

Front axle differential and wheel hubs 32 L

Rear axle differential and wheel hubs 32 L

Hydraulic oil tank 114 L

DEF/AdBlue® tank 25 L

# SPECIFICATIONS

## DIMENSIONS AND SPECIFICATIONS

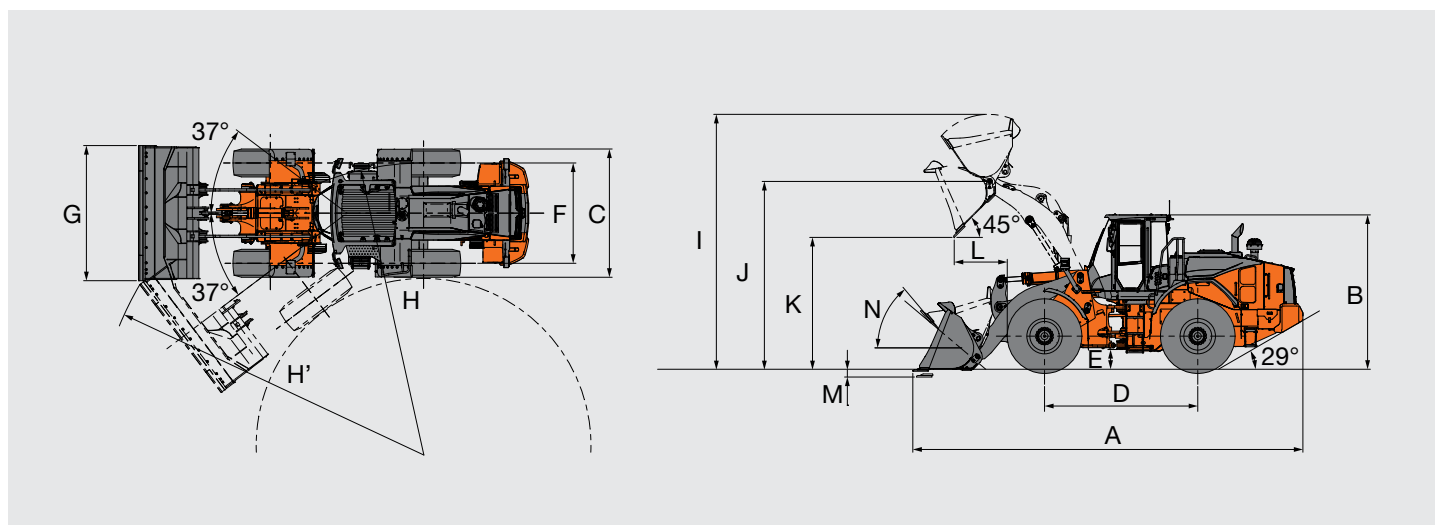

Bucket type		Standard arm		High-lift arm	
		General purpose			
		Bolt-on cutting edge	Bolt-on teeth	Bolt-on cutting edge	
Bucket capacity	ISO 7546 : 1983 Heaped	m <sup>3</sup>	3.4	3.3	2.7
	ISO 7546: 1983 Struck	m <sup>3</sup>	2.9	2.8	2.3
A	Overall length	mm	8 400	8 550	8 730
B	Overall height	up to cab top	mm	3 370	
C	Width over tires	outside tire	mm	2 825	
D	Wheel base	mm		3 300	
E	Ground clearance	Minimum	mm	450	
F	Tread	mm		2 160	
G	Bucket width	mm		2 910	
H	Turning radius (centerline of outside tire)	mm		6 010	
H'	Loader clearance radius, bucket in carry position	mm	6 970	7 010	7 120
I	Overall operating height	bucket full raise	mm	5 520	5 750
J	Height to bucket hinge pin, fully raised	mm	4 080		4 490
K	Dumping clearance 45 degree, full height	mm	2 880	2 770	3 420
L	Reach, 45 degree dump, full height	mm	1 140	1 220	1 170
M	Digging depth (horizontal digging angle)	mm	100	120	180
N	Max. roll back at carry position	deg		50	
Static tipping load *	Straight	kg	15 290	15 520	12 370
	Full 37 degree turn	kg	13 520	13 740	10 910
Breakout force		kN	142	155	152
		kgf	14 571	15 815	15 553
Operating weight *		kg	18 310	18 230	18 320

\*: Static tipping load and operating weight marked with\* include 23.5 R25 (L3) tires (No ballast) with lubricants, full fuel tank and operator. Machine stability and operating weight depend on counterweight, tire size and other attachments.

**WEIGHT CHANGE**

Option item	Operating weight (kg)	Tipping load (kg)		Overall width (mm) (outside tire)	Overall height (mm)	Overall length (mm)
		Straight	Full turn			
Belly guard	+170	+140	+130	-	-	-

**BUCKET SELECTION GUIDE**

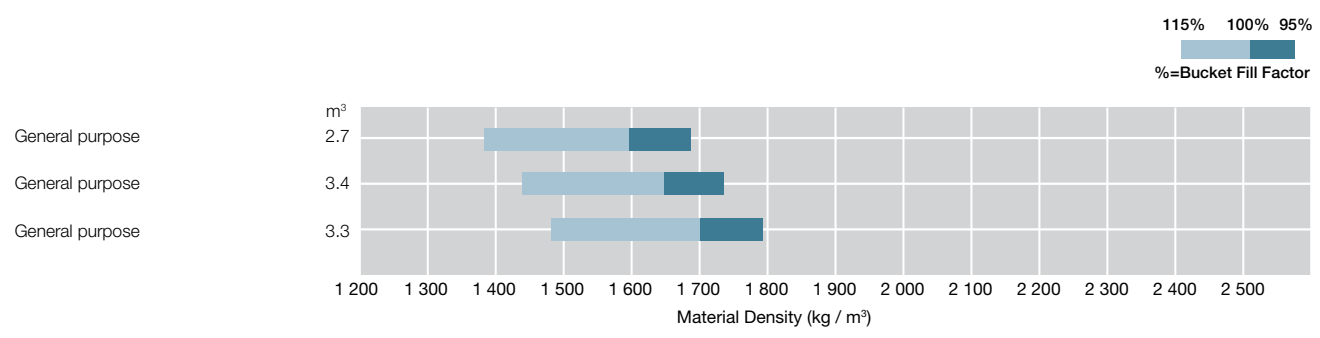

# EQUIPMENTS

● : Standard equipment ○ : Optional equipment

ENGINE	
Air intake	
Pre-cleaner (sy-klone)	●
Air filter double elements	●
Anti-clogging radiator (wide fin pitch radiator)	●
Automatic reversible cooling fan with heat sensing	●
Cartridge-type engine oil filter	●
Cartridge-type fuel pre-filter	●
Cartridge-type fuel main filter	●
Coolant reservoir sight gauge	●
Engine auto shut-down control system	●
Engine oil remote drain	●
Fan guard	●

BRAKE SYSTEM	
Front and rear independent brake circuit	●
Inboard mounted fully hydraulic 4 wheel wet disc	●
Spring-applied/Hydraulic-released parking brake	●

HYDRAULIC SYSTEM	
Bucket auto leveler (automatic return to dig control)	●
Electric control lever	
for 3 spools control valve	
MF lever and Proportional switch for 3rd function	●
for 4 spools control valve	
MF lever and 2 Proportional switches for 3rd and 4th function	○
Control lever lock switch	●
Dual lift arm auto leveler and kickout system	●
Hydraulic filters	●
Lift arm float system	●
Reservoir sight gauge	●
Ride control system (off-auto type)	●
Quick coupler piping and switch	●
Work mode selector	●

CAB	
Adjustable steering column with POP-UP	●
Auto control air conditioner	
with double intake filter	●
Bluetooth® integrated DAB+radio, hands-free calling	●
Camera and monitor	
Rear view camera and monitor	●
AERIAL ANGLE (Side and rear view camera)	○
Coat hook	●
Evacuation hammer	●
Front/rear defroster	●
Glove compartment	●
LED room light	●
Payload checker with tip-off function	●
Rear view mirrors	
Rear view mirrors	●
Outside (heated, 2) electrical adjustment retractable mirror stay	●
ROPS (ISO 3471 : 2008), FOPS (ISO 3449 : 2008 LEVEL II): multi-plane isolation mounted for noise	●
Rubber floor mat	●
Seat	
Heavy duty air suspension seat equipped with horizontal suspension headrest and heater: fabric, high back, adjustable for damper, inclination of the seat, seat depth, weight-height, fore-aft position, reclining angle, armrest angle, headrest height and angle, lumbar support	●
Seat belt reminder	●
Steering system	
Joystick steering (with wheel steering)	○
Wheel steering	●
Storage	
Cup holder	●
Document holder	●
Hot and cool box	●
Smartphone and Tablet device holder	●
Seatback pocket	●
Sunscreen roller type	●
Tinted safety glass	
Front windshield: laminated	●
Others: tempered	●
USB power supply	●
Windshield washer front and rear	●
Windshield wipers front and rear	●
2 speakers	●
8 inch sub monitor	●

● : Standard equipment ○ : Optional equipment

**MONITORING SYSTEM**

Gauge: coolant temperature, fuel level, transmission oil temperature	●
Indicator lights: clearance lights, control lever lock, fuel level, high beam, parking brake, preheat, turn signals, work lights, fan reverse indicator, seat belt indicator	
Indicator on multifunction monitor: F-N-R shift position, gear shift position, clock, DEF alarm indicator, DEF level gauge, ECO indicator, forward/reverse selector switch indicator, hold display, hour meter, joystick steering indicator (optional), odometer, battery volt, speedometer, tachometer, transmission auto-shifting indicator, Warning lights: air filter restriction, brake oil low pressure, communication system error, discharge warning, engine oil low pressure, engine warning, hydraulic oil level, low steering oil pressure, overheat, transmission warning	●
Indicator on sub monitor: payload checker, dual auto-leveler indicator	●
rear obstacle detection and warning system (optional)	
38 languages selection	●

**ELECTRICAL SYSTEM**

Alternator (95 A)	●
Backup alarm	●
Battery disconnect switch	●
Large capacity batteries	●
Power outlet 12 V and 24 V	●

**LIGHTS**

Clearance lights	●
LED brake and tail lights	●
LED headlights	●
Rotating lamp	●
Turn signals with hazard switch	●
Work lights	
2 front on cab and 2 rear LED working lights	●
2 front on cab and 2 rear LED working lights (high brightness)	○
4 front, 2 rear on cab and 2 rear LED working lights	●
4 front, 2 rear on cab and 2 rear LED working lights (high brightness)	○

**POWER TRAIN**

Approach speed control	●
Automatic transmission with load sensing system	●
Clutch cut position switch	●
Differential	
LSD (limited slip differential, front and rear)	○
TPD (torque proportioning differential, front and rear)	●
DSS (down shift switch)	●
Forward/reverse lever	●
Forward/reverse selector switch	●
Maximum gear limited switch	●
Power mode switch	●
Quick power switch	●
Travel mode selector (auto1-auto2)	●

**TIRES**

23.5R25 (L3) XHA2	○
23.5R25 (L3) VJT	●

**MISCELLANEOUS**

Articulation lock bar	●
Belly guard (bolt on type) (front/rear)	●
Bucket cylinder guard	●
Cab top rail	
Front rail on the cab top	●
Rear rail on the cab top	●
Cab window cleaning foot plate	●
Counterweight, built-in	●
Drawbar with locking pin	●
Emergency steering	●
Fenders	
for 23.5R25 (front and full covered rear fenders with mud flaps)	●
Global e-Service	●
Lift arm	
Standard lift arm	●
High lift arm	○
Lift and tie down hooks	●
On board information controller	●
Pilfer proof	
Battery cover with locking bracket	●
Lockable engine cover	●
Lockable fuel refilling cap	●
Standard tool kit	●
Tool box	●

Prior to operating this machine, including satellite communication system, in a country other than a country of its intended use, it may be necessary to make modifications to it so that it complies with the local regulatory standards (including safety standards) and legal requirements of that particular country. Please do not export or operate this machine outside the country of its intended use until such compliance has been confirmed. Please contact your Hitachi dealer in case of questions about compliance.

These specifications are subject to change without notice. Illustrations and photos show the standard models, and may or may not include optional equipment, accessories, and all standard equipment with some differences in color and features. Before use, read and understand the Operator's Manual for proper operation.